

4

DN	PIPE-R	A (mm)	M (Nm)
20	3/4"	> 13	< 65
25	1"	> 15	< 85
32	1-1/4"	> 17	< 100
40	1-1/2"	> 17	< 110
50	2"	> 22	< 135

DN20...32 → 071161036
 DN40...50 → 071161037

V5433A/G

3

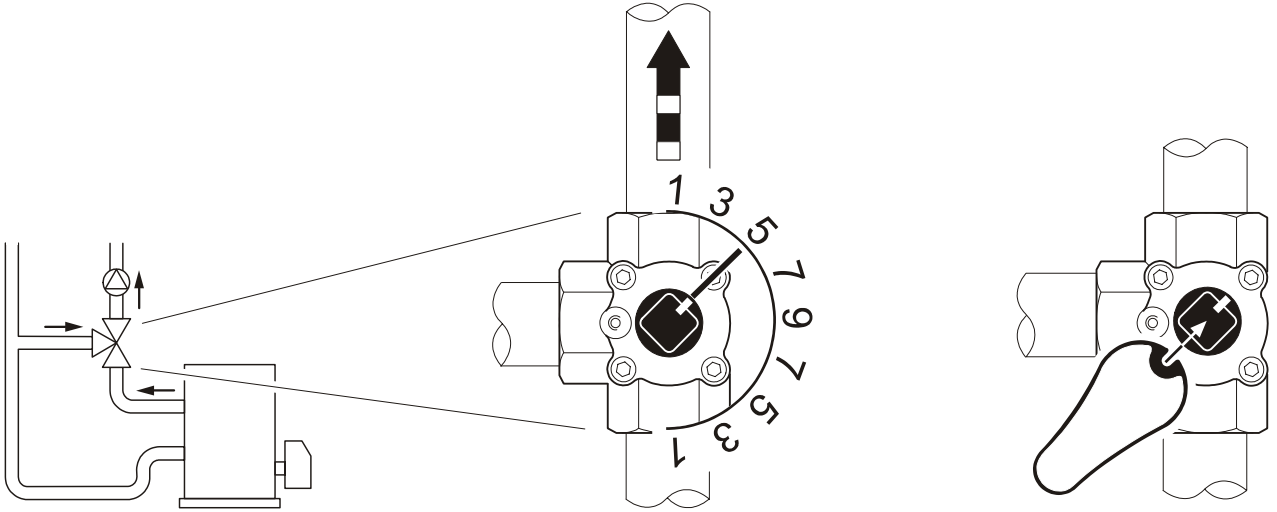

3a

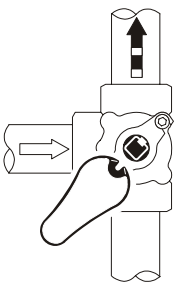
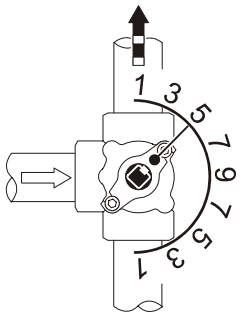
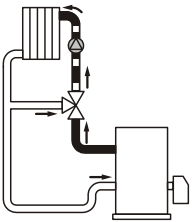

3b

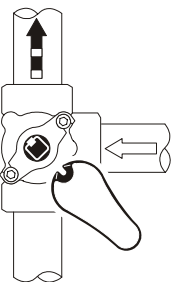
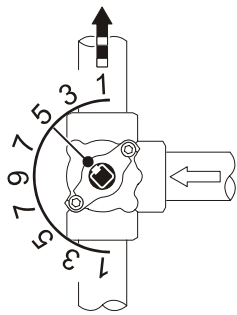
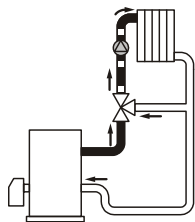

3c

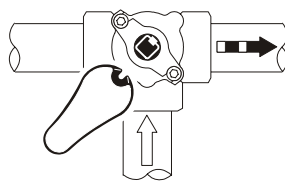
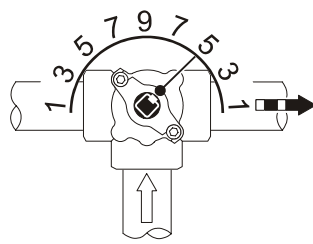
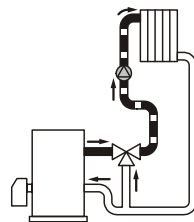

3d

